

heatmiser®



neo stat-hw

Model: **neo** stat-hw

Available in : Sapphire Black and Glacier White

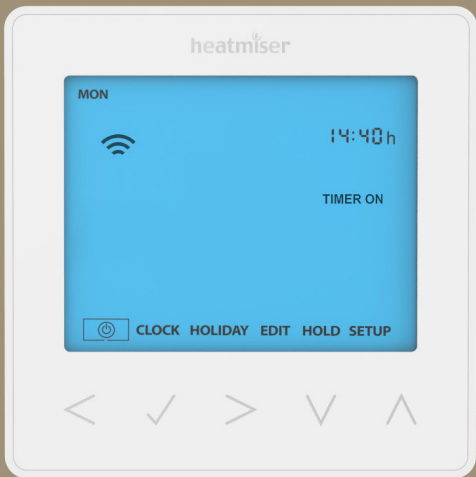

neo Stat Series



Table of Contents

Product Image	1	Optional Features Explained	16
Table of Contents	2	Optional Settings Features Table	16
Installation Procedure	3-4	Factory Reset	17
Pairing the neoHub	5	Wiring Diagrams	18 - 19
Pairing the neoStat-hw	5-6	Notes	20-22
What is a Mesh Network?	6		
Time Clock Mode			
Hot Water Time Clock Display	7-8		
Locking the neoStat-hw	9		
Unlocking the neoStat-hw	9		
Setting the Clock	10		
Setting the Hot Water Times	11		
Hot Water Boost	12		
Standby	13		
Holiday	14		
Adjusting the Optional Settings	15		



Installation Procedure



Do

Mount the time clock at eye level.

Read the instructions fully so you get the best from our product.



Don't

Do not install near to a direct heat source as this will affect functionality.

Do not push hard on the LCD screen as this may cause irreparable damage.

This neoStat-hw is designed to be flush mounted and requires a back box of 35mm (minimum depth) to be sunk into the wall prior to installation.

Step 1

Remove the screw from the bottom face of the time clock then carefully separate the front half from the back plate.

Step 2

Place the time clock front somewhere safe.

Terminate the time clock as shown in the diagrams on pages 18-19 of this booklet.

Step 3

Screw the time clock back plate securely into the back box.

Step 4

Clip the front of the time clock onto the back plate, securing it in place with the retaining screw.

1



2

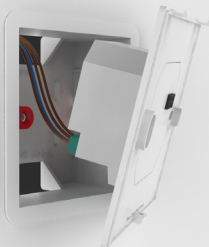

3

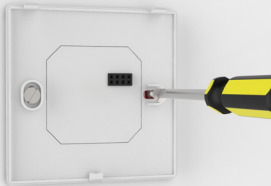

4





Pairing the neoHub

To pair the neoHub with the neoApp, follow these steps.

- Connect the power supply to the neoHub.
- Connect the neoHub to your router with the Ethernet cable provided. The router will automatically assign an IP address to the neoHub, the Link LED will light up once the neoHub has connected to your network.
- Connect your smartphone or tablet device to the same WiFi network as your router.
- Download the FREE Heatmiser neoApp from the Apple App Store, Google Play Store, Amazon App Store or Windows Phone App Store and register an account.
- Once you have registered your account, press the Login button then press the Add Location option.
- Press the connect button on the neoHub to add the location to your account.
- When successfully connected, enter a title for the new location (e.g. Home) and configure the time zone for the system.



Pairing the neoStat-hw

The next step is to join the neoStat-hw to the neoHub, we recommend joining the neoStat-hw located nearest to the neoHub first.

To add a neoStat-hw, follow these steps;

- Select Add Zone, enter a zone title and press Add Zone again.
- You now have two minutes to join the neoStat-hw to the neoHub.
- On the neoStat-hw, use the Left / Right keys to select SETUP and press Tick. <> ✓

- Feature 01 is displayed on screen.
- Press the Tick key to pair the neoStat-hw to the neoHub ✓
- The MESH symbol appears flashing on the display.
- When the neoStat-hw successfully connects to the neoHub the MESH symbol will be permanently displayed.
- Press Next to add more zone or press Finish to complete the setup.

Please note, you only have to pair the hub to your account once. To pair any additional neoStats, select Add Zones from the Manage Zones option in the neoApp.



What is a Mesh Network

NeoStats work using a mesh network, meaning neoStats have the ability to send and receive signals via other thermostats/time clocks on the network.

This signal is relayed from one device to another until it reaches its destination.

This communication method extends the communication range whilst offering increased network stability when compared with standard RF thermostats.

The Mesh symbol is shown when the device is communicating with the neoHub, if the mesh symbol disappears this indicates connection to the neoHub has been lost.



Hot Water Time Clock Display

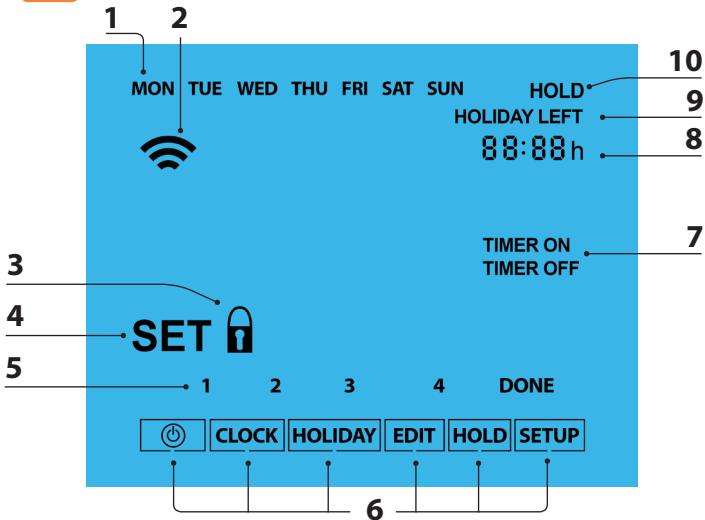

Hot Water Time Clock Display

1. Day Indicator - Displays the day of the week.
2. Mesh Symbol – Displayed when connected to the neoHub.
3. Key Lock Indicator – Displayed when the KeyLock is Locked.
4. Set – Displayed when changes are being made to the program schedule or current set point.
5. Program Indicator – Displayed during programming to show which period is being altered.
6. Main Menu – Displays which option is currently selected.
7. HW Timer Status – Displays if the Hot Water output is ON or OFF.
8. Clock - Time displayed in 24 hour format.
9. Holiday Left – Displayed when the Hot Water Time Clock is in holiday mode.
10. Hold Left – Displayed when Hot Water boost is active, the remaining time will be shown.



Locking the neoStat-hw

The time clock has a keypad lock facility. To activate the lock follow these steps.

- Use the Left / Right keys to scroll to HOLD & press Tick for 10 seconds < > ✓
- The display will show 00:00 and you will need to enter a four digit pin number.
- Use the Up / Down keys to enter the first two digits ^ v
- Press Tick to confirm ✓
- Use the Up / Down keys to enter the second two digits ^ v
- Press Tick to confirm ✓

The display will return to the main screen and display the keypad lock indicator

Note: The keypad lock indicator is only displayed when the lock is active.



Unlocking the neoStat-hw

To unlock the neoStat-hw press Tick once. The display will show 00:00 and you will need to enter the four digit pin number you set previously.

- Use the Up / Down and Tick keys to enter the first two digits ^ v ✓
- Use the Up / Down and Tick keys to enter the second two digits ^ v ✓

The display will unlock and return to the main screen.



Setting the Clock

To set the clock, follow these steps.

- Use the Left / Right keys to scroll to CLOCK < >
- Press Tick to confirm selection ✓
- Use the Up / Down keys to set the hours (24 hour format) ^ v
- Press Tick to confirm selection ✓
- Use Up / Down keys to set the minutes ^ v
- Press Tick to confirm selection ✓
- Use Left / Right keys to set the the day < >
- Press Tick to confirm selection and return to the main display ✓

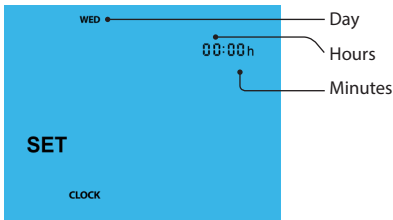



Setting the Hot Water Times

To program the hot water times, follow these steps.

- Use the Left / Right keys to scroll to EDIT and press Tick < > ✓
- Use the Left / Right keys to select day / period of the week < >
- Press Tick to confirm selection ✓
- 1 will now flash and the current ON time will be displayed.
- The OFF time can be viewed by pressing the Down key v
- Select a switching time and press the Tick key ✓
- Use the Up / Down keys to select the ON time HOURS and press Tick ^ v ✓
- Use the Up / Down keys to select the ON time MINUTES ^ v
- Press Tick to confirm selection ✓
- Use the Up / Down keys to select the OFF time HOURS and press Tick ^ v ✓
- Use the Up / Down keys to select the OFF time MINUTES ^ v
- Press Tick to confirm selection ✓
- Press the Right arrow key >
- 2 will now flash and the current ON time will be displayed.
- Repeat the steps above to set all periods. For any unused periods enter -- : --
- When complete, use the Left / Right keys to scroll to DONE and press Tick to confirm all changes < > ✓



Hot Water Boost

To boost the hot water output on, follow these steps.

- Use the Up / Down keys to set the boost duration e.g. 02:00 hours
- Press Tick to confirm settings and return to main display



Hold Left and the remaining time will now be displayed.

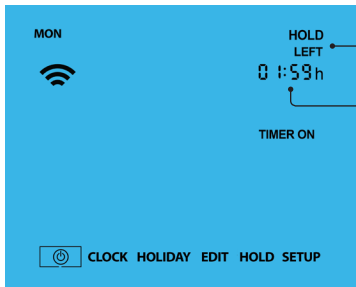

HOLD LEFT Indicator

Hold Time Remaining



Standby

To turn the time clock off completely, scroll to the Power Icon and press the Tick key once. ✓

The timed output will be turned OFF during standby mode.

To turn the time clock back ON, press the Tick key once ✓

Time Clock OFF

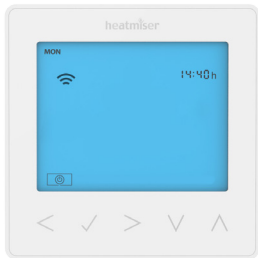

Time Clock ON

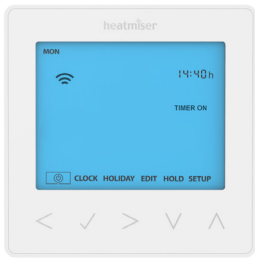



Holiday

During a holiday period, the timed output will be turned OFF and will then automatically return to the program mode on your return.

- Use the Left / Right keys to scroll to HOLIDAY and press Tick
- Using the Up / Down keys enter the number of days holiday
- Press Tick to confirm settings



Note: A holiday period does not start until 00:00 the next day. For example, if you set a holiday period on Friday for 2 days, Saturday will be counted as the first day and the thermostat will revert back to the programmed schedule at 00:00 on Monday.

To cancel a holiday period, repeat these steps but reduce the Holiday duration to 00 days.



Adjusting the Optional Settings

- Use the Left / Right keys to select SETUP
- Press Tick to confirm selection

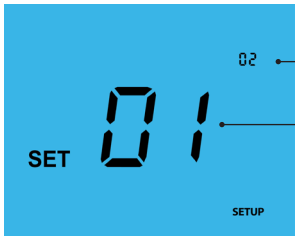

02 — Feature Number

01 — Setting Value

- Use the Up / Down keys to scroll through features
- Use the Left / Right keys to adjust the setting within each feature
- Press Tick to confirm settings





Optional Features Explained

Feature 01 – Pairing to neoHub: This function is used to connect the time clock to the neoHub.

Feature 02 - Weekday/Weekend (5/2), 7 Day Programming or 24 Hour Mode:
The time clock offers three programming methods;

Weekday/ Weekend (5/2) - Allows you to program 4 on/off switching times for the weekdays and 4 on/off switching times for the weekend.

7 Day Program Mode - Each day has 4 on/off switching times that can be programmed independently.

24 Hour Mode - All days are programmed with the same on/off switching times.



Optional Settings - Feature Table

FEATURE	DESCRIPTION	SETTING
01	Pairing	Used to pair to the neoHub
02	Program Mode	01 = Weekday/Weekend Programming (Default) 02 = 7 Day Programming 03 = 24 Hour Mode



Factory Reset

To reset the time clock to factory default settings, follow these steps:

- Use the Left / Right keys to scroll to SETUP
- Press and hold the Tick key for 10 seconds
- All of the icons on the display will appear for 2 seconds, then the display will show two numbers.
- Use the Left / Right keys to select option number 2 (the selection will flash) ...
- Press the Tick key to confirm selection



The time clock will revert to the main display.

Note: Factory reset will cancel all parameters that were entered during the set-up and pairing operations. These processes must be repeated after factory reset is completed.



Wiring Diagram - neoStat-hw (S Plan)

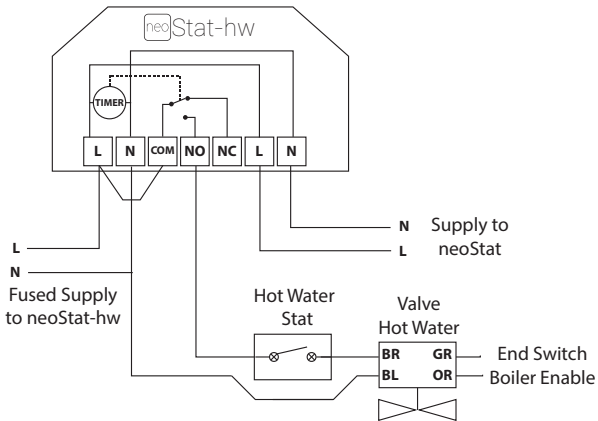

This product must only be installed by a qualified electrician and comply with local installation regulations.



Wiring Diagram - neoStat-hw (mid position valve)

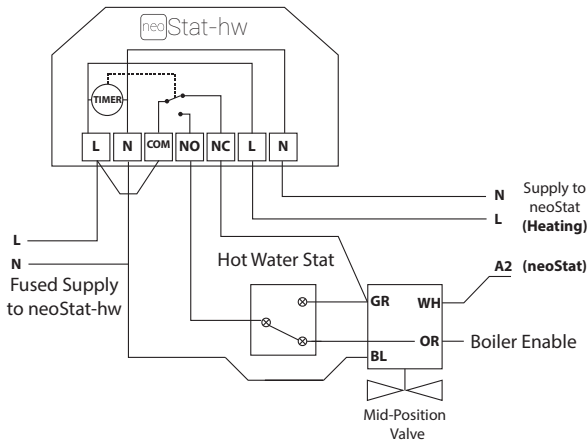

This product must only be installed by a qualified electrician and comply with local installation regulations.



Notes

A series of 18 horizontal dotted lines for writing notes.



Notes

A series of horizontal dotted lines for writing notes, spanning the width of the page.



Notes

A series of 18 horizontal dotted lines for writing notes.



Want More Information?

Call our support team on: +44 (0)1254 669090

Or view technical specifications directly on our website:
www.heatmiser.com



PDF



FAQ



Twitter: [heatmiseruk](https://twitter.com/heatmiseruk)



Facebook: facebook.com/thermostats