



Manual

Head Office:
SALUS Controls plc
SALUS House
Dodworth Business Park South,
Whinby Road, Dodworth,
Barnsley S75 3SP UK.

T: +44 (0) 1226 323961
E: sales@salus-tech.com



www.salus-controls.com

SALUS Controls is a member of the Computime Group.

Maintaining a policy of continuous product development SALUS Controls plc reserve the right to change specification, design and materials of products listed in this brochure without prior notice.

Wiring centre description

1. Cartridge fuse 5 x 20 mm 12 A
2. Power Supply
3. Thermostat grouping status
4. Network Status diode
5. Pair button
6. Reset button

7. Delay jumper
8. INT/EXT antenna jumper
9. NC/NO actuators jumper
10. ZigBee network coordinator
11. Terminals for actuators
12. Pump control output

13. Boiler control output
14. CO terminal
15. Dew point sensor input (humidistat)
16. Serial connector for the KL04RF extension
17. External antenna connector

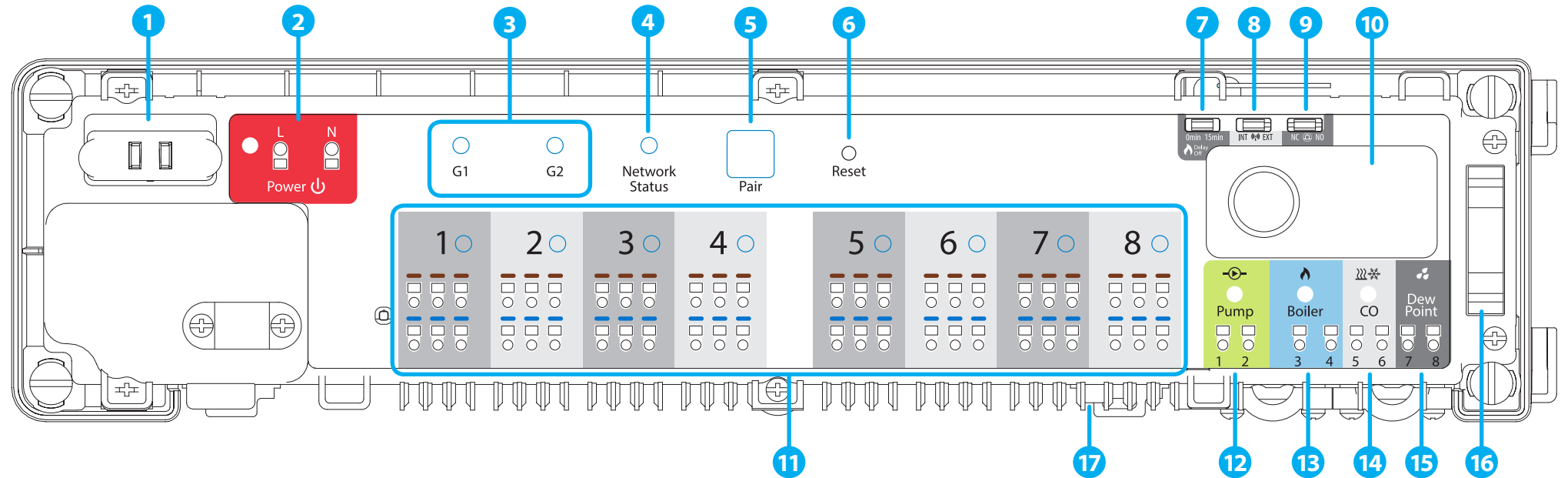

Note: Don't use CO10RF coordinator with UGE600 simultaneously!



◀ RX10RF (optional)
Additional, wireless device control module that can be used - for example - when we can't use cable between the KL08RF wiring centre and the boiler.

Introduction

The KL08RF wireless wiring centre is a part of the iT600RF system. In combination with the wireless thermostats from iT600RF series, KL08RF provides comfortable and reliable heating control. It is equipped with the control outputs for the pump and boiler and has been designed to work with NC or NO actuators.

In Offline mode, communication with the wireless thermostats from iT600RF series must be done through the CO10RF co-ordinating unit, which is in the package together with the wiring centre. To work in Online mode (via the SALUS Smart Home app) KL08RF must be connected to the Internet gateway UGE600. In one ZigBee network (Online or Offline) up to 9 KL08RF wiring centres can be connected. KL08RF increases ZigBee network range.

Product Compliance

This product complies with the essential requirements and other relevant provisions of Directives: EMC 2014/30/EU, LVD 2014/35/EU, RED 2014/53/EU and RoHS 2011/65/EU. The full text of the EU Declaration of Conformity is available at the following internet address: www.saluslegal.com.

Safety Information

Use in accordance with the regulations. Indoor use only. Keep your device completely dry. Disconnect your device before cleaning it with a dry cloth. This accessory must be fitted by a competent person, and installation must comply with the guidance, standards and regulations applicable to the city, country or state where the product is installed. Failure to comply with the relevant standards could lead to prosecution.

Technical Information

Power Supply	230 V AC 50 Hz
Max load	3 A
Inputs	CO terminal Dew point sensor (humidistat)
Outputs	Pump control Boiler control Terminals for actuators
Radio frequency	ZigBee 2,4 GHz
Dimensions [mm]	355x83x67

1. Fuse

Note: Fuse replacement should be done when the wiring centre is disconnected from power supply 230 V AC.

The mains fuse is located under the housing cover, at the main terminals and protects the wiring centre and devices powered by it. Use cartridge fuse-type 5 x 20 mm - nominal burn rate 12 A. To remove the fuse, lift the socket with a flat screwdriver and pull out the fuse.

2. Power Supply

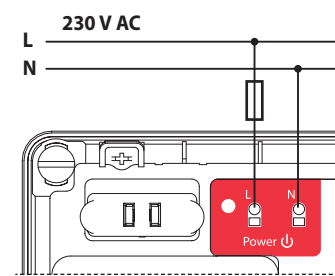

Power supply for wiring centre is 230V ~, 50Hz.

- Features of the installation:
- three-wire, with PE protective conductor,
 - made in accordance with applicable regulations.

3. Thermostat grouping status

This function is only available in Offline mode (together with CO10RF coordinator) - it means MASTER thermostats will affect to SLAVE thermostats within specific group, which is possible only when thermostats are paired with one KL08RF wiring centre (optional + KL04RF) and have been assigned to gr. 1 or gr. 2.

Note: Within one group there may be only one MASTER thermostat (programmable) and the rest must be SLAVE thermostats (non-programmable).

How it works: If all thermostats of a given group will operate in automatic mode, then each of the thermostats in a given group will work in the same way as the MASTER of this group. For example, if the MASTER thermostat of Group 1 according to its programmed schedule maintains a comfort mode - all SLAVE type thermostats from Group 1 will also maintain the comfort mode (the temperature is set individually for every thermostat). Similarly, if the MASTER thermostat is set to Party or Holiday mode - SLAVE thermostats in his group will also work in these modes.

The grouping function is optional - thermostats do not have to be grouped, they can operate independently.

4. Network Status diode

LED diode statuses:

- (LED diode is blinking) - it means wiring centre is not connected to the network, but it is ready for pairing with the coordinator (CO10RF) of the ZigBee network or the Internet gateway (UGE600)
- (LED is steady lit) - it means wiring centre is added to the ZigBee network and paired with CO10RF or UGE600

5. Pair button

Functions of the Pair button:

- Checking the address of the wiring centre in the Zigbee network. To check the address of the wiring centre in the ZigBee network (when using more than one) press the Pair button.

The wiring centre number is indicated by the number of LEDs at the zones:

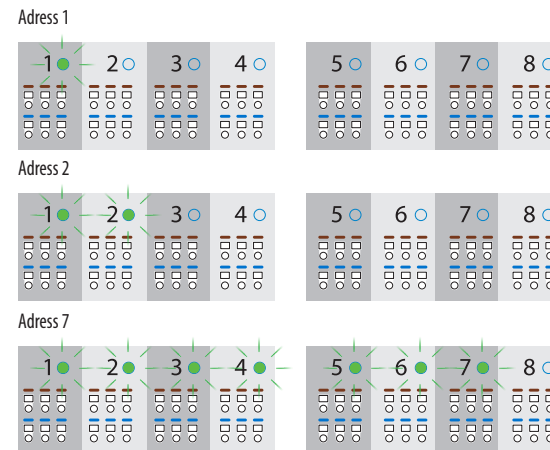

Address 9 is indicated by lighting up 8 LEDs of all the zones and the Network Status LED.

The wiring centre reset (this function is described in detail on the second page of the manual).

6. Reset button

Reset - It is used to refresh the data, after moving jumpers 7,8 or 9. The Reset button does not remove the wiring centre from the ZigBee network.

7. Delay jumper

Boiler off delay time.

Note: Pump (Pump output) and boiler (Boiler output) always starts 3 minutes after receiving the heating signal from any thermostats paired with wiring centre. Pump stops after 3 minutes, when the last thermostat stops sending demand for heat, while the heat source (Boiler) will turn off after the time set with the jumper.

Jumper position change must be refreshed in the memory by pressing the Reset button (short press).

8. INT/EXT antenna jumper

There is an option to connect the 08RFA external antenna to the wiring centre. If you use an additional antenna, place the jumper in the EXT position.

Jumper position change must be refreshed in the memory by pressing the Reset button (short press).

9. NC/NO actuators jumper

Select the type of the thermoelectric actuator connected to the wiring centre:
NC - actuator normally closed
NO - actuator normally opened

Jumper position change must be refreshed in the memory by pressing the Reset button (short press).

10. ZigBee network coordinator

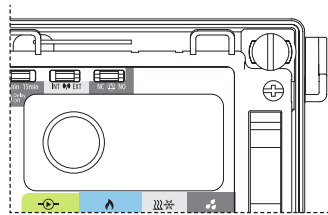

The ZigBee network coordination unit CO10RF is used for Offline mode and it's included with the wiring centre. CO10RF enables wireless control of all devices installed in one network. Within one network can be connected max 9 wiring centres. It means that if in the network there are more than one wiring centre, you can use one coordinator and put the remaining ones in a safe place.

Note: Do not use CO10RF coordinator with UGE600 simultaneously.

11. Terminals for actuators

Wires of the thermoelectric actuators should be plugged into the self-locking connectors in the appropriate zones. You can connect 3 actuators directly to one zone. The current load of one zone is adapted to operate with up to 6 thermoelectric actuators with a power of 2 Watts. If there is a need to connect more than 6 actuators please use an additional relay to relieve the output of the zone.

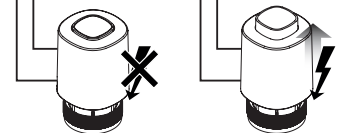
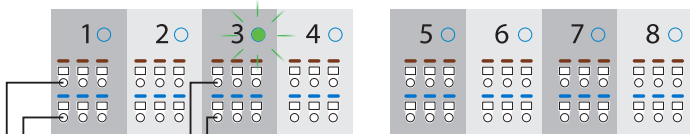

The operation was explained on the example of T30NC actuators.

Note: On the actuator contacts, there is voltage 230 V AC during their work.

12. Pump control output

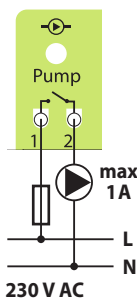

Pump output - this is a volt free output (COM / NO) that controls the circulation pump in the heating / cooling system. The output closes (pump starts) always after 3 minutes after receiving the heating / cooling signal from any of thermostats paired with wiring centre. The output opens (pump stops) after 3 minutes, when the last thermostat stops sending heat / cold demand.

13. Boiler control output

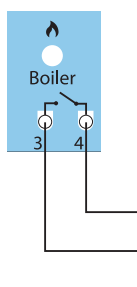

Boiler output - this is a volt free output (COM / NO) that controls the boiler in the heating system. The output closes and the boiler turns on but always after 3 minutes after receiving the heating signal from any of thermostats paired with wiring centre. The output opens and the boiler switches off when the last thermostat stops sending heat demand (after the time set on the Delay jumper).

Note: Boiler output is inactive in the cooling mode.

14. CO terminal (input)

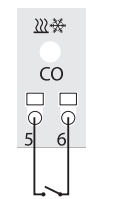

Opened CO input contacts (Changeover) means that whole system works in the heating mode. Short circuit at the input CO will automatically switch the whole system to cooling mode (wiring centre and paired thermostats).

CO terminal	Diode	Mode
Opened contacts	Red	Heating
Closed contacts	Blue	Cooling

15. Dew point sensor input (humidistat)

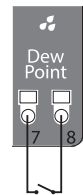

Note: Dew point sensor input is active only in cooling mode (with closed CO contacts).

Shorting the contacts at the dew point sensor input (too high humidity) causes switching off all zones in the wiring centre and Pump control outputs.

16. Serial connector for the KL04RF extension

It is used for communication between the KL08RF wiring centre and the KL04RF extension module. KL04RF extension module increases functionality and expands support up to 12 zones.

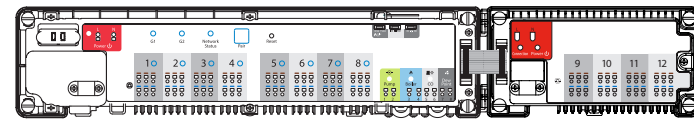

17. External antenna connector

The external antenna connector 08RFA is located underneath the wiring centre under zones 7 and 8. After connecting an additional antenna, place the jumper in the EXT position.

Note: Jumper position change must be refreshed in the memory by pressing the Reset button (short press).



MOUNTING

- Remove the top cover of the wiring centre.
- When wall mounting, unscrew the main part of the housing (see picture). When mounting on the DIN rail tilt the hooks on the back of the housing.
- Attach the back of the wiring centre to the wall.
- Screw the main part of the wiring centre to the back of the housing.
- Remove the appropriate section of insulation from the wires.
- Connect the power cord.
- Connect the rest of the wires.
- Remove the CO10RF coordinator if you use the UGE600 internet gateway.
- Make sure that all the wires are properly connected then connect the power cord to the 230 V AC power supply - red LED diode will light up.
- After finishing installation mount the top cover of wiring centre.

INSTALLATION

1 Connect the wiring centre to the 230 V AC power supply. The Network Status LED will blink.

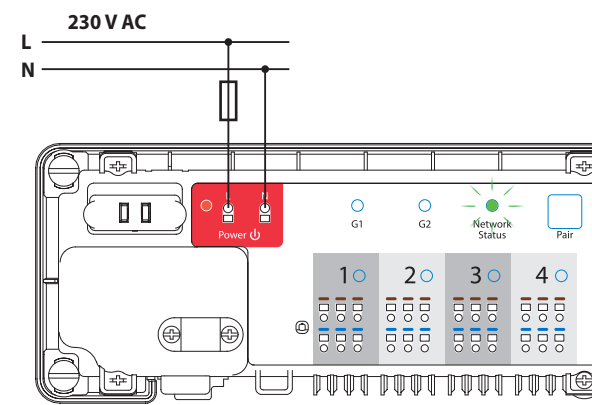

- Online**

Offline

Note: Do not use CO10RF coordinator with UGE600 simultaneously.

Open the ZigBee network

OR

Scan for equipment

3 Wiring centre will connect to the network automatically. The Network Status LED will turn solid green.

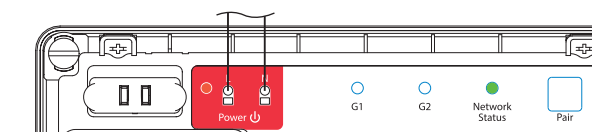

- Online**

Connect equipment

Name this equipment KL08RF wiring centre

Finish

Offline

Close the ZigBee network

OR

Identification of the wiring centre

To identify the wiring centre in the ZigBee network, follow the steps below:

In Online mode (using the SALUS Smart Home app):

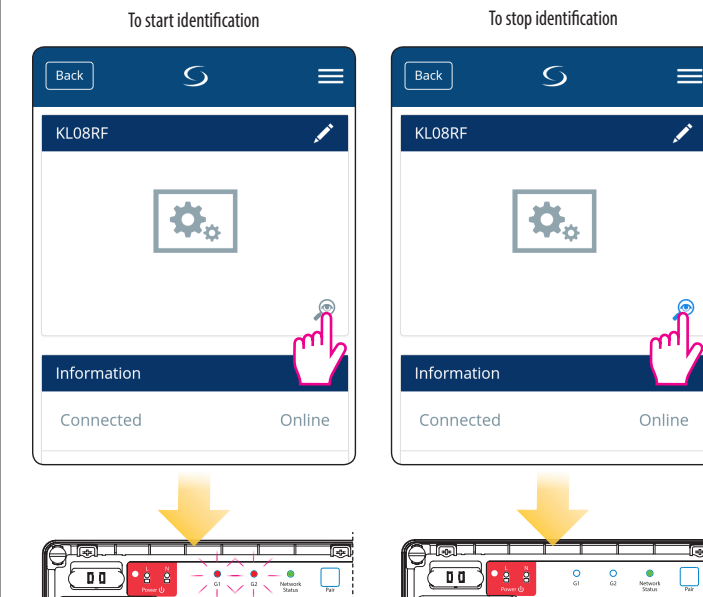

In Offline mode:

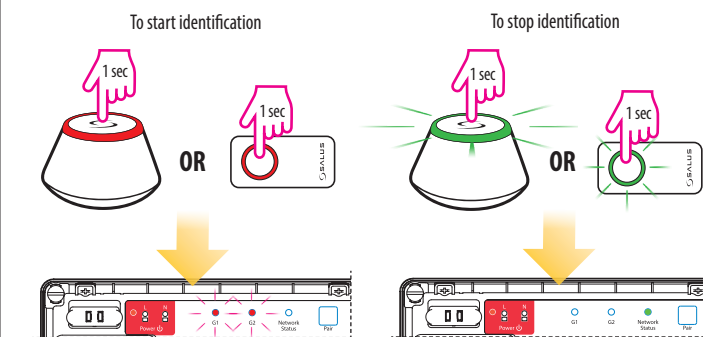

Factory reset

To restore the factory settings, press and hold the Pair button for 15 seconds. G1 and G2 diodes will turn red and go out.

Note: If you restore the factory settings of the wiring centre, all paired devices will be removed from the ZigBee network - you will have to synchronize them again.

